

角パイプ 正方形 SUS304

サイズ	長さ	kg/m	
7x7x1.0	4000	0.22	Ⓜ Ⓞ
9x9x1.0	"	0.25	Ⓜ Ⓞ Ⓟ
10x10x1.0	"	0.28	Ⓜ Ⓞ Ⓟ
10x10x1.2	"	0.34	Ⓜ Ⓞ Ⓟ
12x12x1.0	"	0.35	Ⓜ Ⓞ
12x12x1.2	"	0.41	Ⓜ Ⓞ Ⓟ
13x13x1.0	"	0.38	Ⓜ Ⓞ
13x13x1.2	"	0.45	Ⓜ Ⓞ Ⓟ
14x14x1.0	"	0.41	Ⓜ Ⓞ
14x14x1.2	"	0.49	Ⓜ Ⓞ Ⓟ
16x16x1.0	5000	0.48	Ⓜ Ⓞ Ⓟ
16x16x1.2	"	0.57	Ⓜ Ⓞ Ⓟ
16x16x1.5	"	0.69	Ⓜ Ⓞ Ⓟ
19x19x1.0	5000	0.57	Ⓜ Ⓞ
19x19x1.2	"	0.68	Ⓜ Ⓞ Ⓟ
19x19x1.5	"	0.84	Ⓜ Ⓞ Ⓟ
19x19x2.0	5000	1.08	Ⓜ Ⓞ
20x20x1.2	"	0.72	Ⓜ Ⓞ
20x20x1.5	"	0.88	Ⓜ Ⓞ Ⓟ
21x21x1.0	"	0.64	Ⓜ Ⓞ
21x21x1.2	"	0.76	Ⓜ Ⓞ Ⓟ
21x21x1.5	"	0.93	Ⓜ Ⓞ Ⓟ
22x22x1.0	"	0.67	Ⓜ Ⓞ
22x22x1.2	"	0.79	Ⓜ Ⓞ
22x22x1.5	"	0.98	Ⓜ Ⓞ Ⓟ
24x24x1.0	"	0.73	Ⓜ Ⓞ Ⓟ
24x24x1.2	"	0.87	Ⓜ Ⓞ Ⓟ
24x24x1.5	"	1.07	Ⓜ Ⓞ Ⓟ
25x25x1.2	"	0.91	Ⓜ Ⓞ Ⓟ
25x25x1.5	"	1.12	Ⓜ Ⓞ Ⓟ
25.4x25.4x1.2	5000	0.92	Ⓜ Ⓞ
25.4x25.4x1.5	"	1.14	Ⓜ Ⓞ
28.6x28.6x1.0	"	0.88	Ⓜ Ⓞ
28.6x28.6x1.2	"	1.05	Ⓜ Ⓞ Ⓟ
28.6x28.6x1.5	"	1.29	Ⓜ Ⓞ Ⓟ

Ⓜ = HL Ⓞ = #400 Ⓟ = 未研磨 (HOT)

サイズ	長さ	kg/m	
30x30x1.2	5000	1.10	Ⓜ Ⓞ Ⓟ
30x30x1.5	"	1.36	Ⓜ Ⓞ Ⓟ
30x30x2.0	5000	1.75	Ⓜ Ⓞ Ⓟ
32x32x12	5000	1.18	Ⓜ Ⓞ
32x32x1.5	"	1.45	Ⓜ Ⓞ Ⓟ
32x32x2.0	5000	1.90	Ⓜ Ⓞ Ⓟ
35x35x1.2	"	1.29	Ⓜ Ⓞ
35x35x1.5	"	1.60	Ⓜ Ⓞ Ⓟ
38.5x38.5x1.2	"	1.42	Ⓜ Ⓞ
38.5x38.5x1.5	"	1.76	Ⓜ Ⓞ Ⓟ
38.5x38.5x2.0	"	2.32	Ⓜ Ⓞ
40x40x1.5	"	1.84	Ⓜ Ⓞ Ⓟ
40x40x2.0	5000	2.42	Ⓜ Ⓞ Ⓟ
41x41x1.2	"	1.52	Ⓜ Ⓞ
41x41x1.5	"	1.88	Ⓜ Ⓞ Ⓟ
41x41x2.0	5000	2.48	Ⓜ Ⓞ
46x46x1.5	"	2.11	Ⓜ Ⓞ Ⓟ
46x46x2.0	"	2.77	Ⓜ Ⓞ
50x50x1.5	5000	2.30	Ⓜ Ⓞ Ⓟ
50x50x2.0	5000	3.03	Ⓜ Ⓞ Ⓟ
50x50x3.0	5000	4.42	Ⓜ Ⓞ Ⓟ
60x60x1.5	5000	2.78	Ⓜ Ⓞ Ⓟ
60x60x2.0	5000	3.66	Ⓜ Ⓞ Ⓟ
60x60x3.0	5000	5.38	Ⓜ Ⓞ Ⓟ
75x75x2.0	5000	4.62	Ⓜ Ⓞ Ⓟ
75x75x3.0	5000	6.81	Ⓜ Ⓞ Ⓟ
100x100x2.0	5000	6.21	Ⓜ Ⓞ Ⓟ
100x100x3.0	5000	9.19	Ⓜ Ⓞ Ⓟ

大型角パイプ 正方形 SUS304

サイズ	長さ	kg/m	
40x40x3.0	6000	3.34	Ⓟ
40x40x4.0	"	4.24	Ⓟ
50x50x3.0	"	4.29	Ⓟ
50x50x4.0	"	5.51	Ⓟ
50x50x5.0	"	6.63	Ⓟ
60x60x3.0	"	5.24	Ⓟ
60x60x4.0	"	6.78	Ⓟ
60x60x5.0	"	8.21	Ⓟ
75x75x3.0	"	6.67	Ⓟ
75x75x4.0	"	8.68	Ⓟ
75x75x5.0	"	10.6	Ⓟ
75x75x6.0	"	12.4	Ⓟ
80x80x3.0	"	7.14	Ⓟ
80x80x4.0	"	9.32	Ⓟ
80x80x5.0	"	11.4	Ⓟ
90x90x3.0	"	8.10	Ⓟ
90x90x4.0	"	10.6	Ⓟ
90x90x5.0	"	13.0	Ⓟ
90x90x6.0	"	15.3	Ⓟ
100x100x3.0	"	9.05	Ⓟ
100x100x4.0	"	11.9	Ⓟ
100x100x5.0	"	14.6	Ⓟ
100x100x6.0	"	17.2	Ⓟ
100x100x9.0	"	24.3	Ⓟ
110x110x3.0	"	10.0	Ⓟ
110x110x4.0	"	13.1	Ⓟ
110x110x5.0	"	16.1	Ⓟ
110x110x6.0	"	19.1	Ⓟ
110x110x9.0	"	27.2	Ⓟ
120x120x3.0	"	11.0	Ⓟ
120x120x4.0	"	14.4	Ⓟ
120x120x5.0	"	17.7	Ⓟ
120x120x6.0	"	21.0	Ⓟ
120x120x9.0	"	30.0	Ⓟ
125x125x3.0	"	11.4	Ⓟ
125x125x4.0	"	15.0	Ⓟ
125x125x5.0	"	18.5	Ⓟ
125x125x6.0	"	21.9	Ⓟ
125x125x9.0	"	31.5	Ⓟ

Ⓟ = 未研磨 (HOT) ■ = 受注製作品

サイズ	長さ	kg/m	
150x150x3.0	6000	13.8	Ⓟ
150x150x4.0	"	18.2	Ⓟ
150x150x5.0	"	22.5	Ⓟ
150x150x6.0	"	26.7	Ⓟ
150x150x9.0	"	38.6	Ⓟ
150x150x12.0	"	49.6	Ⓟ ■
175x175x3.0	"	16.2	Ⓟ
175x175x4.0	"	21.4	Ⓟ
175x175x5.0	"	26.5	Ⓟ
175x175x6.0	"	31.4	Ⓟ
175x175x9.0	"	45.7	Ⓟ
175x175x12.0	"	59.1	Ⓟ ■
200x200x3.0	"	18.6	Ⓟ
200x200x4.0	"	24.5	Ⓟ
200x200x5.0	"	30.4	Ⓟ
200x200x6.0	"	36.2	Ⓟ
200x200x9.0	"	52.9	Ⓟ
200x200x12.0	"	68.6	Ⓟ ■
250x250x4.0	"	30.9	Ⓟ
250x250x5.0	"	38.4	Ⓟ
250x250x6.0	"	45.7	Ⓟ
250x250x9.0	"	67.1	Ⓟ
250x250x12.0	"	87.7	Ⓟ ■
300x300x4.0	"	37.2	Ⓟ
300x300x5.0	"	46.3	Ⓟ
300x300x6.0	"	55.2	Ⓟ
300x300x9.0	"	81.4	Ⓟ
300x300x12.0	"	107.0	Ⓟ ■

角パイプ 長方形 SUS304

サイズ	長さ	kg/m	
19x10x1.0	4000	0.43	Ⓜ Ⓞ
19x10x1.2	"	0.51	Ⓜ Ⓞ Ⓢ
22x12x1.0	5000	0.51	Ⓜ Ⓞ
22x12x1.2	"	0.60	Ⓜ Ⓞ
22x12x1.5	"	0.74	Ⓜ Ⓞ Ⓢ
24x14x1.0	"	0.57	Ⓜ Ⓞ
24x14x1.2	"	0.68	Ⓜ Ⓞ
24x14x1.5	"	0.84	Ⓜ Ⓞ Ⓢ
25x12x1.2	"	0.66	Ⓜ Ⓞ Ⓢ
25x12x1.5	"	0.81	Ⓜ Ⓞ Ⓢ
30x20x1.2	"	0.9	Ⓜ Ⓞ
30x20x1.5	"	1.12	Ⓜ Ⓞ Ⓢ
	6000		Ⓜ Ⓢ
30x25x1.2	5000	1.00	Ⓜ Ⓞ
30x25x1.5	"	1.24	Ⓜ Ⓞ Ⓢ
40x18x1.0	"	0.89	Ⓜ Ⓞ
40x18x1.2	"	1.06	Ⓜ Ⓞ Ⓢ
40x18x1.5	"	1.31	Ⓜ Ⓞ Ⓢ
40x20x1.2	"	1.10	Ⓜ Ⓞ
40x20x1.5	"	1.36	Ⓜ Ⓞ Ⓢ
	6000		Ⓜ Ⓢ
40x20x2.0	5000	1.79	Ⓜ Ⓞ Ⓢ
40x25x1.2	"	1.19	Ⓜ Ⓞ
40x25x1.5	"	1.48	Ⓜ Ⓞ Ⓢ
	6000		Ⓜ Ⓢ
40x25x2.0	5000	1.93	Ⓜ Ⓞ Ⓢ
50x20x1.2	"	1.29	Ⓜ
50x20x1.5	"	1.60	Ⓜ Ⓞ Ⓢ
	6000		Ⓜ Ⓢ
50x20x2.0	5000	2.09	Ⓜ Ⓞ Ⓢ
50x25x1.5	"	1.72	Ⓜ Ⓞ Ⓢ
	6000		Ⓜ Ⓢ
50x25x2.0	5000	2.26	Ⓜ Ⓞ Ⓢ
50x30x1.5	"	1.84	Ⓜ Ⓞ Ⓢ
	6000		Ⓜ Ⓢ
50x30x2.0	5000	2.42	Ⓜ Ⓞ Ⓢ
51x26x1.2	"		Ⓜ Ⓞ
51x26x1.5	"		Ⓜ Ⓞ Ⓢ
51x26x2.0	"		Ⓜ Ⓞ Ⓢ

Ⓜ = HL Ⓞ = #400 Ⓢ = 未研磨

サイズ	長さ	kg/m	
60x25x1.5	5000	1.96	Ⓜ Ⓞ Ⓢ
60x25x2.0	"	2.58	Ⓜ Ⓞ
60x30x1.5	5000	2.06	Ⓜ Ⓞ Ⓢ
	6000		Ⓜ Ⓢ
60x30x2.0	5000	2.71	Ⓜ Ⓞ Ⓢ
	6000		Ⓜ Ⓢ
60x40x1.5	5000	2.30	Ⓜ Ⓞ
60x40x2.0	"	3.03	Ⓜ Ⓞ Ⓢ
61x32x1.5	5000	2.13	Ⓜ Ⓞ Ⓢ
	6000		Ⓜ Ⓢ
61x32x2.0	5000	2.80	Ⓜ Ⓞ
65x18x1.2	"	1.54	Ⓜ Ⓞ
65x18x1.5	"	1.91	Ⓜ Ⓞ Ⓢ
70x25x1.5	"	2.18	Ⓜ Ⓞ
70x25x2.0	"	2.86	Ⓜ Ⓞ
70x30x1.5	"	2.30	Ⓜ Ⓞ
70x30x2.0	"	3.03	Ⓜ Ⓞ
75x45x1.5	5000	2.78	Ⓜ Ⓞ Ⓢ
	6000		Ⓜ Ⓢ
75x45x2.0	5000	3.66	Ⓜ Ⓞ Ⓢ
	6000		Ⓜ Ⓢ
75x45x3.0	5000	5.38	Ⓜ Ⓞ Ⓢ
80x40x1.5	5000	2.78	Ⓜ Ⓞ Ⓢ
	6000		Ⓜ Ⓢ
80x40x2.0	5000	3.66	Ⓜ Ⓞ Ⓢ
	6000		Ⓜ Ⓢ
80x40x3.0	5000	5.38	Ⓜ Ⓞ
90x30x1.5	5000	2.78	Ⓜ Ⓞ Ⓢ
90x30x2.0	"	3.66	Ⓜ Ⓞ Ⓢ
90x30x3.0	"	5.38	Ⓜ Ⓞ
90x50x1.5	5000	3.25	Ⓜ Ⓢ
90x50x2.0	"	4.30	Ⓜ
90x50x3.0	"	6.31	Ⓜ
100x40x2.0	5000	4.30	Ⓜ Ⓞ Ⓢ
100x40x3.0	"	6.31	Ⓜ Ⓞ Ⓢ
100x50x2.0	5000	4.62	Ⓜ Ⓞ Ⓢ
	6000		Ⓜ Ⓢ
100x50x3.0	5000	6.81	Ⓜ Ⓞ Ⓢ
	6000		Ⓜ Ⓢ

角パイプ 長方形 SUS304

サイズ	長さ	kg/m	
120x60x2.0	5000	5.57	Ⓜ Ⓞ Ⓢ
120x60x3.0	"	8.24	Ⓜ Ⓞ Ⓢ
125x75x2.0	"	6.22	Ⓜ Ⓢ
125x75x3.0	"	9.23	Ⓜ Ⓢ
150x50x2.0	"	6.21	Ⓜ Ⓞ Ⓢ
150x50x3.0	"	9.19	Ⓜ Ⓞ Ⓢ

角パイプ 長方形 SUS304

サイズ	長さ	kg/m	
32x16x1.0	5000	0.73	Ⓜ
32x16x1.2	"	1.87	Ⓜ

フラット角パイプ 長方形 SUS304

サイズ	長さ	kg/m	
6x12x1.0	4000	0.25	Ⓜ
6x12x1.2	"	0.30	Ⓜ
6x25x1.2	"	0.46	Ⓜ
6x25x1.5	"	0.54	Ⓜ
6x30x1.2	"	0.63	Ⓜ
6x30x1.5	"	0.78	Ⓜ
6x40x1.2	"	0.82	Ⓜ
6x40x1.5	"	1.00	Ⓜ
6x50x1.2	"	0.99	Ⓜ
6x50x1.5	"	1.22	Ⓜ
6x65x1.5	"	1.52	Ⓜ
6x75x1.5	"	1.76	Ⓜ
6x100x1.5	"	2.30	Ⓜ
9x25x1.5	"	0.74	Ⓜ
9x30x1.5	"	0.85	Ⓜ
9x40x1.5	"	1.07	Ⓜ
9x50x1.2	"	1.05	Ⓜ
9x50x1.5	"	1.3	Ⓜ
9x65x1.2	"	1.31	Ⓜ
9x65x1.5	"	1.61	Ⓜ
9x75x1.5	"	1.83	Ⓜ
9x100x1.5	"	2.37	Ⓜ
10x40x1.5	"	1.09	Ⓜ
12x50x1.2	"	1.10	Ⓜ
12x50x1.5	"	1.35	Ⓜ
12x65x1.5	"	1.67	Ⓜ
12x75x1.5	"	1.89	Ⓜ
12x100x1.5	"	2.43	Ⓜ

大型角パイプ 長方形 SUS304

◎ = 未研磨 (HOT) ■ = 受注製作品

サイズ	長さ	kg/m		サイズ	長さ	kg/m	
60x30x3.0		3.81	◎	200x150x3.0		16.2	◎
60x30x4.0		4.88	◎	200x150x4.0		21.4	◎
				200x150x5.0		26.5	◎
75x45x3.0		5.24	◎	200x150x6.0		31.4	◎
75x45x4.0		6.78	◎	200x150x9.0		45.7	◎ ■
				200x150x12.0		59.1	◎ ■
80x40x3.0		5.24	◎	250x150x3.0		18.6	◎
80x40x4.0		6.78	◎	250x150x4.0		24.5	◎
				250x150x5.0		30.4	◎
90x50x3.0		6.19	◎	250x150x6.0		36.2	◎
90x50x4.0		8.05	◎	250x150x9.0		52.9	◎ ■
				250x150x12.0		68.6	◎ ■
100x40x3.0		6.19	◎	300x200x4.0		30.9	◎
100x40x4.0		8.05	◎	300x200x5.0		38.4	◎
				300x200x6.0		45.7	◎
100x50x3.0		6.67	◎	300x200x9.0		67.1	◎ ■
100x50x4.0		8.68	◎	300x200x12.0		87.7	◎ ■
100x50x5.0		10.6	◎				
100x50x6.0		12.4	◎				
125x75x3.0		9.05	◎				
125x75x4.0		11.9	◎				
125x75x5.0		14.6	◎				
125x75x6.0		17.2	◎				
150x75x3.0		10.2	◎				
150x75x4.0		13.4	◎				
150x75x5.0		16.5	◎				
150x75x6.0		19.5	◎				
150x100x3.0		11.4	◎				
150x100x4.0		15.0	◎				
150x100x5.0		18.5	◎				
150x100x6.0		21.9	◎				
150x100x9.0		31.5	◎				
200x75x3.0		12.6	◎				
200x75x4.0		16.6	◎				
200x75x5.0		20.5	◎				
200x75x6.0		24.3	◎				
200x75x9.0		35.0	◎ ■				
200x100x3.0		13.8	◎				
200x100x4.0		18.2	◎				
200x100x5.0		22.5	◎				
200x100x6.0		26.7	◎				
200x100x9.0		38.6	◎ ■				
200x100x12.0		49.6	◎ ■				

フラットバー SUS304

サイズ	長さ	kg/m	
2x6	2000	0.10	◎
2x8	"	0.06	◎
2x10	3000	0.16	◎
	4000		◎
2x12	"	0.19	◎
2x15	"	0.24	◎
2x20	"	0.32	◎
2x25	"	0.40	◎
2x30	"	0.48	◎
2x32	"	0.51	◎
2x40	"	0.64	◎
2x50	"	0.79	◎
3x3	2000	0.07	◎
3x6	3000	0.14	◎
	4000		◎
3x8	"	0.19	◎
3x9	"	0.21	◎
3x10	"	0.24	⊕ ◎
3x12	"	0.29	⊕ ◎
3x13	"	0.31	⊕ ◎
3x15	"	0.36	⊕ ⊕ ◎
3x16	"	0.38	⊕ ◎
3x19	"	0.45	⊕ ◎
3x20	"	0.48	⊕ ⊕ ◎
3x22	"	0.52	⊕ ◎
3x25	"	0.60	⊕ ⊕ ◎
3x30	"	0.72	⊕ ⊕ ◎
3x32	"	0.76	⊕ ⊕ ◎
3x35	"	0.83	⊕ ◎
3x38	"	0.91	⊕ ⊕ ◎
3x40	"	0.95	⊕ ⊕ ◎
3x42	"	1.00	⊕ ◎
3x45	"	1.07	⊕ ◎
3x50	"	1.19	⊕ ⊕ ◎
3x60	"	1.43	⊕ ⊕ ◎
3x65	"	1.55	⊕ ◎
3x75	"	1.78	⊕ ◎
3x100	"	2.38	⊕ ◎
3x110	"	1.63	◎
3x120	"	2.85	◎
3x125	"	2.98	◎
3x130	"	3.10	◎
3x140	"	3.33	◎
3x150	"	3.58	◎

⊕ = HL ⊕ = #400 ◎ = COLD

サイズ	長さ	kg/m	
4x4	4000	0.13	◎
4x9	"	0.29	◎
4x10	"	0.32	⊕ ◎
4x11	"	0.35	⊕ ◎
4x13	"	0.41	⊕ ◎
4x15	"	0.48	⊕ ⊕ ◎
4x16	"	0.51	⊕ ◎
4x19	"	0.60	⊕ ◎
4x20	"	0.64	⊕ ⊕ ◎
4x22	"	0.70	⊕ ◎
4x25	"	0.79	⊕ ⊕ ◎
4x30	"	0.95	⊕ ⊕ ◎
4x32	"	1.02	⊕ ⊕ ◎
4x35	"	1.11	⊕ ◎
4x38	"	1.21	⊕ ⊕ ◎
4x40	"	1.27	⊕ ⊕ ◎
4x45	"	1.43	⊕ ◎
4x50	"	1.59	⊕ ⊕ ◎
4x60	"	1.90	⊕ ◎
4x65	"	2.03	⊕ ◎
4x75	"	2.38	⊕ ◎
4x90	"	2.85	⊕ ◎
4x100	"	3.18	⊕ ◎
5x5	4000	0.20	⊕ ◎
5x8	"	0.32	◎
5x9	"	0.36	◎
5x10	"	0.40	⊕ ◎
5x12	"	0.48	⊕ ◎
5x13	"	0.52	⊕ ◎
5x15	"	0.60	⊕ ⊕ ◎
5x16	"	0.64	⊕ ◎
5x19	"	0.75	⊕ ◎
5x20	"	0.79	⊕ ⊕ ◎
5x22	"	0.87	⊕ ◎
5x25	"	0.99	⊕ ⊕ ◎
5x30	"	1.19	⊕ ⊕ ◎
5x32	"	1.27	⊕ ⊕ ◎
5x35	"	1.39	⊕ ◎
5x38	"	1.51	⊕ ⊕ ◎
5x40	"	1.59	⊕ ⊕ ◎
5x50	"	1.98	⊕ ⊕ ◎
5x60	"	2.38	⊕ ◎
5x65	"	2.58	⊕ ◎
5x75	"	2.98	⊕ ◎
5x90	"	3.58	⊕ ◎
5x100	"	3.95	⊕ ◎
5x130	"	5.15	◎
5x150	"	5.95	⊕ ◎

フラットバー SUS304

サイズ	長さ	kg/m	
6x6	4000	0.29	⊕ ◎
6x9	"	0.43	◎
6x10	"	0.48	⊕ ◎
6x12	"	0.57	⊕ ◎
6x13	"	0.62	⊕ ◎
6x15	"	0.72	⊕ ⊕ ◎
6x16	"	0.76	⊕ ◎
6x18	"	0.86	⊕ ◎
6x19	"	0.91	⊕ ◎
6x20	"	0.95	⊕ ⊕ ◎
6x22	"	1.05	⊕ ◎
6x25	"	1.19	⊕ ⊕ ◎
6x30	"	1.43	⊕ ⊕ ◎
6x32	"	1.52	⊕ ⊕ ◎
6x35	"	1.67	⊕ ◎
6x38	"	1.81	⊕ ⊕ ◎
6x40	"	1.90	⊕ ⊕ ◎
6x42	"	2.00	⊕ ◎
6x45	"	2.14	⊕ ⊕ ◎
6x50	"	2.38	⊕ ⊕ ◎
	6000		⊕ ◎
6x60	4000	2.85	⊕ ⊕ ◎
	"		⊕ ◎
6x65	"	3.10	⊕ ⊕ ◎
	6000		⊕ ◎
6x70	4000	3.33	⊕ ◎
	"		⊕ ⊕ ◎
6x75	"	3.58	⊕ ◎
	6000		⊕ ◎
6x90	4000	4.28	⊕ ◎
	"		⊕ ⊕ ◎
6x100	"	4.75	⊕ ◎
	6000		⊕ ◎
6x110	4000	5.23	⊕ ◎
6x120	"	5.70	⊕ ◎
6x125	"	5.95	⊕ ◎
6x130	"	6.20	⊕ ◎
6x140	"	6.65	⊕ ◎
6x150	"	7.15	⊕ ◎
7x7	4000	0.39	⊕ ◎
8x8	4000	0.51	⊕ ⊕ ◎
8x10	"	0.64	⊕ ◎
8x16	"	1.02	⊕ ◎
8x32	"	2.03	⊕ ◎
8x38	"	2.41	⊕ ◎
8x50	"	3.18	⊕ ◎

⊕ = HL ⊕ = #400 ◎ = COLD

サイズ	長さ	kg/m	
9x9	4000	0.64	⊕ ⊕ ◎
9x13	"	0.93	⊕ ◎
9x15	"	1.07	⊕ ◎
9x16	"	1.14	⊕ ◎
9x19	"	1.36	⊕ ◎
9x20	"	1.43	⊕ ⊕ ◎
9x22	"	1.57	⊕ ◎
9x25	"	1.78	⊕ ⊕ ◎
	6000		⊕ ◎
9x30	4000	2.14	⊕ ⊕ ◎
	6000		⊕ ◎
9x32	4000	2.28	⊕ ⊕ ◎
	6000		⊕ ◎
9x38	"	2.70	⊕ ⊕ ◎
	6000		⊕ ◎
9x40	4000	2.85	⊕ ⊕ ◎
	6000		⊕ ◎
9x50	4000	3.58	⊕ ⊕ ◎
	6000		⊕ ◎
9x60	4000	4.28	⊕ ◎
9x65	"	4.65	⊕ ⊕ ◎
	6000		⊕ ◎
9x75	4000	5.34	⊕ ⊕ ◎
	6000		8.03
9x90	4000	6.43	⊕ ◎
9x100	"	7.15	⊕ ◎
	6000		⊕ ◎
9x125	4000	8.93	⊕ ◎
9x150	"	10.7	⊕ ◎
9x200	"	14.3	⊕ ◎
9x250	"	17.8	⊕ ◎
9x300	"	21.4	◎

フラットバー SUS304

サイズ	長さ	kg/m	
10x10	4000	0.79	Ⓜ Ⓞ Ⓢ
10x15	"	1.19	Ⓜ Ⓢ
10x19	"	1.51	Ⓜ Ⓢ
10x20	"	1.59	Ⓜ Ⓞ Ⓢ
10x25	"	1.98	Ⓜ Ⓞ Ⓢ
10x30	"	2.38	Ⓜ Ⓞ Ⓢ
10x32	"	2.55	Ⓜ Ⓞ Ⓢ
10x38	"	3.00	Ⓜ Ⓞ Ⓢ
10x40	"	3.18	Ⓜ Ⓞ Ⓢ
10x50	"	3.95	Ⓜ Ⓞ Ⓢ
10x65	"	5.15	Ⓜ Ⓞ Ⓢ
10x75	"	5.95	Ⓜ Ⓞ Ⓢ
10x100	"	7.93	Ⓜ Ⓢ
10x125	"	9.90	Ⓜ Ⓢ
10x150	"	11.9	Ⓜ Ⓢ
10x200	"	15.9	Ⓜ Ⓢ
10x250	"	19.8	Ⓜ Ⓢ
10x300	"	23.8	Ⓢ
12x12	4000	1.14	Ⓜ Ⓞ Ⓢ
12x14	"	1.33	Ⓢ
12x16	"	1.52	Ⓜ Ⓢ
12x19	"	1.81	Ⓜ Ⓢ
12x20	"	1.90	Ⓜ Ⓞ Ⓢ
12x25	"	2.38	Ⓜ Ⓞ Ⓢ
12x30	"	2.85	Ⓜ Ⓞ Ⓢ
12x32	"	3.05	Ⓜ Ⓞ Ⓢ
	6000		Ⓜ Ⓢ
12x35	4000	3.33	Ⓜ Ⓢ
12x38	"	3.63	Ⓜ Ⓞ Ⓢ
	6000		Ⓜ Ⓢ
12x40	4000	3.80	Ⓜ Ⓞ Ⓢ
	6000		Ⓜ Ⓢ
12x50	4000	4.75	Ⓜ Ⓞ Ⓢ
	6000		Ⓜ Ⓢ
12x65	4000	6.20	Ⓜ Ⓞ Ⓢ
	6000		Ⓜ Ⓢ
12x75	4000	7.15	Ⓜ Ⓞ Ⓢ
	6000		Ⓜ Ⓢ
12x90	4000	8.55	Ⓜ Ⓢ
12x100	"	9.53	Ⓜ Ⓢ
	6000		Ⓜ Ⓢ
12x125	4000	11.9	Ⓜ Ⓢ
12x150	"	14.3	Ⓜ Ⓢ
12x200	"	19.0	Ⓜ Ⓢ
12x250	"	23.8	Ⓜ Ⓢ
12x300	"	28.5	Ⓢ
13x13	4000	1.34	
14x14	4000	1.55	Ⓜ Ⓞ Ⓢ

Ⓜ = HL Ⓞ = #400 Ⓢ = COLD

サイズ	長さ	kg/m	
15x15	4000	1.78	Ⓜ Ⓞ Ⓢ
16x16	4000	2.03	Ⓜ Ⓞ Ⓢ
16x19	"	2.41	Ⓜ Ⓢ
16x20	"	2.55	Ⓜ Ⓞ Ⓢ
16x25	"	3.18	Ⓜ Ⓞ Ⓢ
16x32	"	4.05	Ⓜ Ⓞ Ⓢ
16x38	"	4.83	Ⓜ Ⓞ Ⓢ
16x40	"	5.08	Ⓜ Ⓢ
16x50	"	6.35	Ⓜ Ⓞ Ⓢ
16x65	"	8.25	Ⓜ Ⓢ
16x75	"	9.53	Ⓜ Ⓢ
16x100	"	12.7	Ⓜ Ⓢ
16x125	"	15.9	Ⓜ Ⓢ
16x150	"	19.0	Ⓜ Ⓢ
16x200	"	25.5	Ⓜ Ⓢ
16x250	"	31.8	Ⓜ Ⓢ
16x300	"	38.0	Ⓢ
19x19	4000	2.85	Ⓜ Ⓞ Ⓢ
19x25	"	3.85	Ⓜ Ⓞ Ⓢ
19x32	"	4.83	Ⓜ Ⓞ Ⓢ
19x38	"	5.73	Ⓜ Ⓞ Ⓢ
19x50	"	7.53	Ⓜ Ⓞ Ⓢ
19x65	"	9.80	Ⓜ Ⓢ
19x75	"	11.3	Ⓜ Ⓢ
19x100	"	15.1	Ⓜ Ⓢ
19x125	"	18.8	Ⓜ Ⓢ
19x150	"	22.6	Ⓜ Ⓢ
19x200	"	30.0	Ⓜ Ⓢ
19x250	"	37.8	Ⓜ Ⓢ
19x300	"	45.3	Ⓢ
20x20	4000	3.18	Ⓜ Ⓞ Ⓢ
22x22	4000	3.85	Ⓜ Ⓞ Ⓢ
22x32	"	5.58	Ⓢ
22x38	"	6.63	Ⓢ
22x50	"	8.73	Ⓢ
22x65	"	11.3	Ⓢ
22x75	"	13.1	Ⓢ
22x100	"	17.4	Ⓢ

フラットバー SUS304

サイズ	長さ	kg/m	
25x25	4000	4.95	Ⓜ Ⓞ Ⓢ
25x32	"	6.35	Ⓢ
25x38	"	7.60	Ⓢ
25x50	"	9.90	Ⓢ
25x65	"	12.9	Ⓢ
25x75	"	14.9	Ⓢ
25x100	"	19.8	Ⓢ
25x125	"	24.8	Ⓢ
25x150	"	29.8	Ⓢ
25x200	"	39.5	Ⓢ
25x250	"	49.5	Ⓢ
25x300	"	59.5	Ⓢ
26x26	4000	5.35	Ⓢ
28x28	4000	6.23	Ⓢ
30x30	4000	7.15	Ⓢ
30x50	"	11.9	Ⓢ
30x55	"	13.1	Ⓢ
30x65	"	15.5	Ⓢ
30x75	"	17.8	Ⓢ
30x100	"	23.8	Ⓢ
32x32	4000	8.13	Ⓢ
35x50	4000	13.9	Ⓢ
35x65	"	18.0	Ⓢ
35x75	"	20.8	Ⓢ
35x100	"	27.8	Ⓢ
36x36	4000	10.3	Ⓢ
38x38	4000	11.5	Ⓢ
40x40	4000	12.7	Ⓢ
45x45	4000	16.1	Ⓢ
50x50	4000	19.8	Ⓢ
55x55	4000	24.0	Ⓢ
60x60	4000	28.5	Ⓢ
65x65	4000	33.5	Ⓢ

ラウンドフラットバー SUS304

サイズ	長さ	kg/m	
3x15	4000	0.34	Ⓜ
3x20	"	0.46	Ⓜ
3x25	"	0.58	Ⓜ
3x30	"	0.70	Ⓜ
3x32	"	0.75	Ⓜ
3x40	"	0.94	Ⓜ
3x50	"	1.18	Ⓜ
3x65	"	1.53	Ⓜ
3x75	"	1.77	Ⓜ
3x100	"	2.37	Ⓜ
6x25	4000	1.12	Ⓜ
6x30	"	1.36	Ⓜ
6x40	"	1.92	Ⓜ
6x50	"	2.31	Ⓜ
6x65	"	3.03	Ⓜ
6x75	"	3.50	Ⓜ
6x100	"	4.70	Ⓜ
9x30	4000	2.00	Ⓜ
9x40	"	2.70	Ⓜ
9x50	"	3.43	Ⓜ
9x65	"	4.50	Ⓜ
9x75	"	5.20	Ⓜ
9x100	"	7.00	Ⓜ



化粧パイプ SUS304

㊦ = HL ㊧ = #400

サイズ	長さ	kg/m	
5φx0.8	4000	0.08	㊧
5φx1.0	"	0.10	㊧
6φx0.8	4000	0.10	㊧
6φx1.0	"	0.12	㊧
7φx0.8	4000	0.12	㊧
7φx1.0	"	0.15	㊧
8φx0.8	4000	0.14	㊧
8φx1.0	"	0.17	㊦㊧
9φx0.8	4000	0.16	㊧
9φx1.0	"	0.20	㊧
10φx0.8	4000	0.18	㊧
10φx1.0	"	0.22	㊦㊧
12φx0.8	4000	0.22	㊧
12φx1.0	"	0.27	㊦㊧
13φx0.8	4000	0.24	㊧
13φx1.0	"	0.30	㊦㊧
13φx1.2	"	0.35	㊦㊧
13φx1.5	"	"	㊦㊧
	5000	0.43	㊦㊧
	6000	"	㊦㊧
13.8φx1.2	4000	0.38	㊦㊧
13.8φx1.5	"	0.46	㊦㊧
14φx0.8	4000	0.26	㊧
14φx1.0	"	0.32	㊧
15φx0.8	4000	0.28	㊧
15φx1.0	"	0.35	㊧
16φx0.8	4000	0.30	㊧
16φx1.0	"	0.37	㊦㊧
16φx1.2	"	0.44	㊦㊧
16φx1.5	"	"	㊦㊧
	5000	0.54	㊦㊧
	6000	"	㊦㊧
16φx2.0	4000	0.70	㊦㊧
17.3φx1.5	4000	"	㊦㊧
	5000	0.59	㊦㊧
	6000	"	㊦㊧
17.3φx2.0	4000	"	㊦㊧
	5000	0.76	㊦㊧
	6000	"	㊦㊧

サイズ	長さ	kg/m	
19φx0.8	4000	0.36	㊧
19φx1.0	"	0.45	㊦㊧
19φx1.2	4000	0.53	㊦㊧
19φx1.5	"	"	㊦㊧
	5000	0.65	㊦㊧
	6000	"	㊦㊧
19φx2.0	4000	0.85	㊦㊧
	6000	"	㊦㊧
21.7φx1.0	4000	0.52	㊧
21.7φx1.2	"	0.61	㊦㊧
21.7φx1.5	"	"	㊦㊧
	5000	0.76	㊦㊧
	6000	"	㊦㊧
21.7φx2.0	4000	"	㊦㊧
	5000	0.98	㊦㊧
	6000	"	㊦㊧
21.7φx3.0	4000	1.40	㊦㊧
	6000	"	㊦㊧
22φx0.8	4000	0.42	㊧
22φx1.0	"	0.52	㊦㊧
22φx1.2	"	0.62	㊦㊧
22φx1.5	"	"	㊦㊧
	5000	0.77	㊦㊧
	6000	"	㊦㊧
22φx2.0	4000	"	㊦㊧
	5000	1.00	㊦㊧
	6000	"	㊦㊧
25φx0.8	4000	0.48	㊧
25φx1.0	"	0.60	㊦㊧
25φx1.2	"	0.71	㊦㊧
25φx1.5	"	"	㊦㊧
	5000	0.88	㊦㊧
	6000	"	㊦㊧
25φx2.0	4000	"	㊦㊧
	5000	1.15	㊦㊧
	6000	"	㊦㊧
25φx3.0	4000	1.65	㊦㊧
25.4φx1.0	4000	0.61	㊧
25.4φx1.2	"	0.73	㊦㊧
25.4φx1.5	"	0.89	㊦㊧
25.4φx2.0	"	1.17	㊦㊧

化粧パイプ SUS304

㊦ = HL ㊧ = #400

サイズ	長さ	kg/m	
27.2φx1.0	4000	0.66	㊦㊧
27.2φx1.2	"	0.78	㊦㊧
27.2φx1.5	"	"	㊦㊧
	5000	0.96	㊦㊧
	6000	"	㊦㊧
27.2φx2.0	4000	"	㊦㊧
	5000	1.26	㊦㊧
	6000	"	㊦㊧
27.2φx3.0	4000	"	㊦㊧
	5000	1.81	㊦㊧
	6000	"	㊦㊧
30φx1.5	4000	1.07	㊧
30φx2.0	"	1.40	㊧
32φx1.0	4000	0.78	㊦㊧
32φx1.2	"	0.92	㊦㊧
32φx1.5	"	"	㊦㊧
	5000	1.14	㊦㊧
	6000	"	㊦㊧
32φx2.0	4000	"	㊦㊧
	5000	1.50	㊦㊧
	6000	"	㊦㊧
32φx3.0	4000	"	㊦㊧
	5000	2.17	㊦㊧
	6000	"	㊦㊧
34φx1.0	4000	0.83	㊦㊧
34φx1.2	"	0.98	㊦㊧
34φx1.5	"	"	㊦㊧
	5000	1.22	㊦㊧
	6000	"	㊦㊧
34φx2.0	4000	"	㊦㊧
	5000	1.60	㊦㊧
	6000	"	㊦㊧
34φx3.0	4000	"	㊦㊧
	5000	2.32	㊦㊧
	6000	"	㊦㊧
38φx1.0	4000	0.93	㊦㊧
38φx1.2	"	1.10	㊦㊧
38φx1.5	"	"	㊦㊧
	5000	1.37	㊦㊧
	6000	"	㊦㊧
38φx2.0	4000	"	㊦㊧
	5000	1.80	㊦㊧
	6000	"	㊦㊧
38φx3.0	4000	"	㊦㊧
	5000	2.62	㊦㊧
	6000	"	㊦㊧
42.7φx1.2	4000	1.25	㊦㊧
42.7φx1.5	"	"	㊦㊧
	5000	1.54	㊦㊧
	6000	"	㊦㊧
42.7φx2.0	4000	"	㊦㊧
	5000	2.03	㊦㊧
	6000	"	㊦㊧
42.7φx3.0	4000	"	㊦㊧
	5000	2.97	㊦㊧
	6000	"	㊦㊧
45φx1.5	4000	1.63	㊦㊧
45φx2.0	"	2.15	㊦㊧
48.6φx1.2	4000	1.42	㊦㊧
48.6φx1.5	"	"	㊦㊧
	5000	1.77	㊦㊧
	6000	"	㊦㊧
48.6φx2.0	4000	"	㊦㊧
	5000	2.33	㊦㊧
	6000	"	㊦㊧
48.6φx3.0	4000	"	㊦㊧
	5000	3.41	㊦㊧
	6000	"	㊦㊧
50φx1.0	4000	1.23	㊧
50φx1.2	"	1.47	㊦㊧
50φx1.5	"	"	㊦㊧
	5000	1.82	㊦㊧
	6000	"	㊦㊧
50φx2.0	4000	"	㊦㊧
	5000	2.40	㊦㊧
	6000	"	㊦㊧
50φx3.0	4000	"	㊦㊧
	5000	3.52	㊦㊧
	6000	"	㊦㊧
50.8φx1.5	4000	1.85	㊧
60.5φx1.5	4000	"	㊦㊧
	5000	2.21	㊦㊧
	6000	"	㊦㊧
60.5φx2.0	4000	"	㊦㊧
	5000	2.92	㊦㊧
	6000	"	㊦㊧
60.5φx3.0	4000	"	㊦㊧
	5000	4.31	㊦㊧
	6000	"	㊦㊧
60.5φx4.0	4000	"	㊦㊧
	6000	5.64	㊦㊧

化粧パイプ SUS304

⊕ = HL ⊙ = #400

サイズ	長さ	kg/m		サイズ	長さ	kg/m	
76.3φ×1.5	4000	2.81	⊕ ⊙				
	6000		⊕ ⊙				
76.3φ×2.0	4000	3.72	⊕ ⊙				
	6000		⊕ ⊙				
76.3φ×3.0	4000	5.49	⊕ ⊙				
	6000		⊕ ⊙				
76.3φ×4.0	4000	7.22	⊕ ⊙				
	6000		⊕ ⊙				
89.1φ×1.5	4000	3.30	⊕ ⊙				
89.1φ×2.0	4000	4.36	⊕ ⊙				
	6000		⊕ ⊙				
89.1φ×3.0	4000	6.46	⊕ ⊙				
	6000		⊕ ⊙				
89.1φ×4.0	4000	8.50	⊕ ⊙				
	6000		⊕ ⊙				
101.6φ×1.5	4000	3.77	⊕ ⊙				
101.6φ×2.0	4000	4.99	⊕ ⊙				
	6000		⊕ ⊙				
101.6φ×3.0	4000	7.40	⊕ ⊙				
	6000		⊕ ⊙				
101.6φ×4.0	4000	9.75	⊕ ⊙				
	6000		⊕ ⊙				
114.3φ×2.0	4000	5.63	⊕ ⊙				
	6000		⊕ ⊙				
114.3φ×3.0	4000	8.35	⊕ ⊙				
	6000		⊕ ⊙				
114.3φ×4.0	4000	11.0	⊕ ⊙				
	6000		⊕ ⊙				
139.8φ×2.0	4000	6.92	⊕ ⊙				
	6000		⊕ ⊙				
139.8φ×3.0	4000	10.3	⊕ ⊙				
	6000		⊕ ⊙				
139.8φ×4.0	4000	13.6	⊕ ⊙				
	6000		⊕ ⊙				
165.2φ×3.0	4000	12.2	⊕ ⊙				
	6000		⊕ ⊙				
165.2φ×4.0	4000	16.1	⊕ ⊙				
	6000		⊕ ⊙				
216.3φ×3.0	4000	16.1	⊕ ⊙				
	6000		⊕ ⊙				
216.3φ×4.0	4000	21.3	⊕ ⊙				
	6000		⊕ ⊙				

楕円パイプ SUS304

形状	サイズ	長さ	kg/m	
	DA型 28x16x1.2	5000	0.63	Ⓜ
	40x20x1.5	〃		Ⓜ
	50x20x1.5	〃	1.36	Ⓜ
	60x30x1.5	〃	1.76	Ⓜ
	71x23x1.2	〃	1.46	Ⓜ
	71x23x1.5	〃	1.81	Ⓜ
	84x28x1.5	〃	2.32	Ⓜ
	120x45x2.0	〃	4.35	Ⓜ
	220x100x3.0	6000		Ⓜ ■
	DB型 35x19x3.0	5000	1.01	Ⓜ
DC型 30x6x1.5	4000		Ⓜ ■	
40x6x1.5	〃		Ⓜ ■	
50x6x1.5	〃		Ⓜ ■	
30x9x1.5	〃		Ⓜ ■	
40x9x1.5	〃		Ⓜ ■	
50x9x1.5	〃		Ⓜ ■	
40x12x1.5	〃		Ⓜ	
50x12x1.5	〃		Ⓜ	
37x14x1.5	5000	1.01	Ⓜ	
40x15x1.5	〃	1.14	Ⓜ	
46x20x1.2	〃	1.10	Ⓜ	
46x20x1.5	〃	1.37	Ⓜ	
65x20x1.5	〃	1.81	Ⓜ	
80x25x1.5	〃	2.17	Ⓜ	
〃	〃	〃	Ⓜ ■	
100x35x2.0	6000	3.70	Ⓜ ■	

Ⓜ = HL Ⓞ = #400 ■ = 受注製作品

半円パイプ SUS304

形状	サイズ	長さ	kg/m	
	40x20x1.5	5000	1.14	Ⓜ
	50x25x1.5	〃	1.45	Ⓜ
	60x30x1.5	〃	1.76	Ⓜ
		6000	Ⓜ	
	60x30x2.0	5000	2.74	Ⓜ
		6000	Ⓜ	
	80x40x2.0	5000	3.00	Ⓜ
		6000	Ⓜ ■	
	100x50x2.0	5000	3.98	Ⓜ

D形パイプ SUS304

形状	サイズ	長さ	kg/m	
	34x25x30x1.5	4000	1.21	Ⓜ Ⓞ ■
	34x25x30x2.0	〃	1.59	Ⓜ Ⓞ ■
	38x31x30x1.5	〃	1.36	Ⓜ Ⓞ ■
	38x31x30x2.0	〃	1.79	Ⓜ Ⓞ ■
	42.7x34.5x30x1.5	〃	1.54	Ⓜ Ⓞ ■
	42.7x34.5x30x1.5	〃	2.03	Ⓜ Ⓞ ■

甲丸パイプ SUS304

形状	サイズ	長さ	kg/m	
	62x40x1.5	6000	2.21	Ⓜ
	62x40x2.0	〃	2.93	Ⓜ
	80x47.5x2.0	〃	3.70	Ⓜ

丸棒 SUS304

サイズ	長さ	kg/m		サイズ	長さ	kg/m	
2φ	4000	0.03	○	48φ	4000	14.3	● ○
2.5φ	〃	0.04	○	50φ	〃	15.6	● ○
3φ	〃	0.06	○	55φ	〃	18.8	● ○
3.5φ	〃	0.08	○	60φ	〃	22.4	● ○
4φ	〃	0.10	○	65φ	〃	26.3	● ○
5φ	〃	0.16	○	70φ	〃	30.5	● ○
6φ	〃	0.22	○	75φ	〃	35.0	● ○
7φ	〃	0.31	○	80φ	〃	39.9	● ○
8φ	〃	0.40	Ⓜ Ⓞ ● ○	85φ	〃	45.3	●
9φ	〃	0.50	Ⓜ Ⓞ ● ○	90φ	〃	50.7	●
10φ	〃	0.62	Ⓜ Ⓞ ● ○	95φ	〃	56.5	●
11φ	〃	0.75	○	100φ	〃	62.6	●
12φ	〃	0.90	Ⓜ Ⓞ ● ○	105φ	〃	69.0	●
13φ	〃	1.05	Ⓜ Ⓞ ● ○	110φ	〃	75.7	●
14φ	〃	1.22	Ⓜ Ⓞ ○	115φ	〃	82.7	●
15φ	〃	1.40	Ⓜ Ⓞ ● ○	120φ	〃	90.1	●
16φ	〃	1.59	Ⓜ Ⓞ ● ○	125φ	〃	97.7	●
17φ	〃	1.80	Ⓞ ○	130φ	〃	106	●
18φ	〃	2.02	Ⓞ ● ○	135φ	〃	114	●
19φ	〃	2.25	Ⓜ Ⓞ ● ○	140φ	〃	123	●
20φ	〃	2.49	Ⓜ Ⓞ ● ○	145φ	〃	132	●
22φ	〃	3.01	Ⓜ Ⓞ ● ○	150φ	〃	141	●
24φ	〃	3.59	○	155φ	〃	152	●
25φ	〃	3.89	Ⓜ Ⓞ ● ○	160φ	〃	161	●
26φ	〃	4.25	●	170φ	〃	182	●
28φ	〃	4.88	● ○	180φ	〃	204	●
30φ	〃	5.61	● ○	190φ	〃	227	●
32φ	〃	6.38	● ○	200φ	〃	252	●
34φ	〃	7.30	●	210φ	〃	277	●
35φ	〃	7.63	● ○	220φ	〃	304	●
36φ	〃	8.07	● ○	230φ	〃	332	●
38φ	〃	8.99	● ○	240φ	〃	362	●
40φ	〃	9.97	● ○	250φ	〃	392	●
42φ	〃	11.0	● ○				
44φ	〃	12.1	●				
45φ	〃	12.6	● ○				

Ⓜ = HL Ⓞ = 未研磨 (HOT) ● = ピーリング ○ = 引抜き

- 【ピーリング】 ピーリングとは「皮をむく」という意味です。
熱処理後の棒鋼の表面の黒皮を、りんごの皮をむくように切削した光沢のある仕上げです。
- 【引抜き】 冷間引抜(コールド ドロー)の略称です。ダイスを通して冷間引抜加工したもので、表面は光沢があり、ピーリングや酸洗よりも寸法精度が良好です。

鉄筋(異形丸鋼)

	長さ	kg/m		長さ	kg/m
D10	4000	0.57		D19	6000
	6000			D22	〃
D13	4000	1.00		D25	〃
	6000			D32	〃
D16	4000	1.57		D35	〃
	6000			D38	〃

アングル SUS304

⊕ = HL ⊕ = #400 ⊙ = 酸洗 (HOT)

サイズ	長さ	kg/m	
3x20x20	4000	0.90	⊕ ⊕ ⊙
3x25x25	"	1.13	⊕ ⊕ ⊙
3x30x30	"	1.37	⊕ ⊕ ⊙
	6000		⊕ ⊕ ⊙
3x35x35	4000	1.61	⊙
3x40x40	"	1.85	⊕ ⊕ ⊙
	6000		⊕ ⊕ ⊙
3x45x45	"	2.13	⊙
3x50x50	4000	2.37	⊙
	6000		⊙
4x30x30	6000	1.77	⊙
4x35x35	"	2.10	⊙
4x40x40	4000	2.43	⊕ ⊕ ⊙
	6000		⊕ ⊕ ⊙
4x45x45	"	2.77	⊙
4x50x50	4000	3.08	⊕ ⊕ ⊙
	6000		⊕ ⊙
4x55x55	"	3.40	⊙
5x30x30	6000	2.18	⊙
5x35x35	"	2.58	⊙
5x40x40	4000	2.98	⊕ ⊙
	6000		⊕ ⊕ ⊙
5x45x45	"	3.42	⊙
5x50x50	4000	5.73	⊕ ⊙
	6000		⊕ ⊕ ⊙
5x60x60	"	4.60	⊕ ⊕ ⊙
5x65x65	"	5.05	⊕ ⊕ ⊙
5x70x70	"	5.45	⊕ ⊕ ⊙
5x75x75	"	5.83	⊕ ⊕ ⊙
6x30x30	6000	2.53	⊙
6x35x35	"	3.03	⊙
6x40x40	"	3.50	⊙
6x45x45	"	4.02	⊙
6x50x50	4000	4.48	⊕ ⊙
	6000		⊕ ⊕ ⊙
6x55x55	"	4.97	⊙
6x60x60	"	5.43	⊙
6x65x65	4000	5.97	⊕ ⊙
	6000		⊕ ⊕ ⊙
6x70x70	"	6.43	⊙
6x75x75	4000	6.92	⊕ ⊙
	6000		⊕ ⊕ ⊙
6x80x80	"	7.40	⊙
6x90x90	"	8.37	⊙
6x100x100	"	9.32	⊙
7x70x70	6000	7.42	⊙

サイズ	長さ	kg/m	
8x50x50	6000	5.78	⊙
8x60x60	"	7.05	⊙
8x65x65	"	7.73	⊙
8x70x70	"	8.37	⊙
8x75x75	"	9.02	⊙
8x80x80	"	9.63	⊙
8x90x90	"	11.0	⊙
8x100x100	"	12.2	⊙
9x50x50	6000	6.43	⊙
9x60x60	"	7.87	⊙
9x65x65	"	8.63	⊙
9x70x70	"	9.35	⊙
9x75x75	4000	10.1	⊕ ⊙
	6000		⊕ ⊕ ⊙
9x80x80	"	10.8	⊙
9x90x90	"	12.3	⊙
9x100x100	"	13.7	⊙
9x125x125	"	17.2	⊙
10x50x50	6000	7.08	⊙
10x60x60	"	8.68	⊙
10x65x65	"	9.52	⊙
10x75x75	"	11.1	⊙
10x80x80	"	11.8	⊙
10x90x90	"	13.5	⊙
10x100x100	4000	15.1	⊙
	6000		⊕ ⊙
12x75x75	6000	13.1	⊙
12x80x80	"	14.0	⊙
12x90x90	"	16.0	⊙
12x100x100	"	17.8	⊙
12x125x125	"	22.7	⊙
12x130x130	"	23.7	⊙
12x150x150	"	27.5	⊙
15x125x125	6000	28.0	⊙
15x150x150	"	33.8	⊙

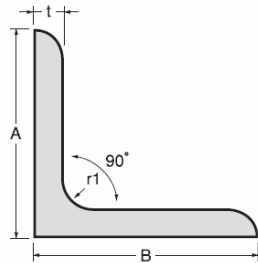

不等辺アングル SUS304

サイズ	長さ	kg/m	
4x45x30	6000	2.67	⊙
6x50x30	6000	3.57	⊙
6x65x50	"	5.28	⊙
6x75x60	"	5.73	⊙
6x75x65	"	6.47	⊙
6x100x75	"	8.13	⊙
6x125x75	"	9.32	⊙
7x75x50	6000	6.58	⊙
7x100x75	"	9.45	⊙
9x75x50	6000	8.33	⊙
9x90x75	"	11.2	⊙
9x100x75	"	11.9	⊙
9x125x75	"	13.7	⊙
9x150x90	"	16.5	⊙
12x150x90	6000	21.7	⊙

コールドアングル (ピン角アングル) SUS304

サイズ	長さ	kg/m	
3x20x20	4000	0.89	⊙
3x25x25	"	1.12	
3x30x30	"	1.36	⊙
	6000		⊙
3x40x40	4000	1.83	⊙
	6000		⊙
3x50x50	4000	2.32	⊙
	6000		⊙
4x30x30	6000	1.78	⊙
4x40x40	"	2.42	⊙
4x50x50	"	3.05	
5x30x30	6000	2.18	⊙
5x40x40	"	2.98	⊙
5x50x50	"	3.77	⊙
6x30x30	6000	2.58	
6x40x40	"	3.53	
6x50x50	"	4.48	
6x60x60	"	5.43	
6x65x65	"	5.92	
6x75x75	"	6.87	
9x50x50	6000	6.50	
9x75x75	"	10.1	

不等辺アングル SUS304

サイズ	長さ	kg/m	
150x150x3.0	6000	13.8	⊙
150x150x4.0	"	18.2	⊙
150x150x5.0	"	22.5	⊙
150x150x6.0	"	26.7	⊙
150x150x9.0	"	38.6	⊙
150x150x12.0	"	49.6	⊙ ■
175x175x3.0	"	16.2	⊙
175x175x4.0	"	21.4	⊙
175x175x5.0	"	26.5	⊙
175x175x6.0	"	31.4	⊙
175x175x9.0	"	45.7	⊙
175x175x12.0	"	59.1	⊙ ■
200x200x3.0	"	18.6	⊙
200x200x4.0	"	24.5	⊙
200x200x5.0	"	30.4	⊙
200x200x6.0	"	36.2	⊙
200x200x9.0	"	52.9	⊙
200x200x12.0	"	68.6	⊙ ■
250x250x4.0	"	30.9	⊙
250x250x5.0	"	38.4	⊙
250x250x6.0	"	45.7	⊙
250x250x9.0	"	67.1	⊙
250x250x12.0	"	87.7	⊙ ■
300x300x4.0	"	37.2	⊙
300x300x5.0	"	46.3	⊙
300x300x6.0	"	55.2	⊙
300x300x9.0	"	81.4	⊙
300x300x12.0	"	107.0	⊙ ■

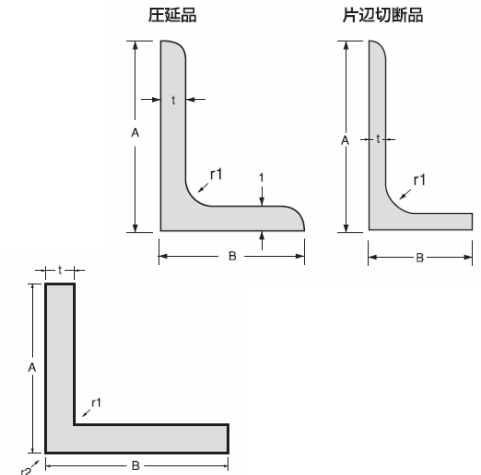

チャンネル SUS304

サイズ	長さ	kg/m	
3x20x40	6000	1.80	◎
3x25x50	"	2.28	◎
4x50x100	4000	6.50	◎
	6000		◎
5x40x80	4000	5.98	◎
	6000		◎
5x50x100	4000	7.65	◎
	6000		◎
6x50x100	4000	9.00	◎
	6000		◎
6x60x120	6000	10.9	◎
6x65x130	4000	12.0	◎
	6000		◎
6x75x150	4000	13.9	◎
	6000		◎
9x75x150	4000	20.3	◎
	6000		◎
10x100x200	4000	30.3	◎
	6000		◎

ワイドチャンネル SUS304 (溶接品)

サイズ	長さ	kg/m	
6x65x220	6000	16.3	◎
6x65x230	"	16.6	◎
6x75x250	"	18.6	◎
6x75x250	"	27.5	◎
9x90x250	"	29.7	◎
9x90x300	"	33.2	◎
9x100x300	"	34.3	◎
10x100x250	"	34.3	◎
10x90x300	"	36.7	◎
10x100x300	"	37.2	◎

C型鋼 SUS304 ◎ = 酸洗 (HOT) ■ = 受注製作品

サイズ	長さ	kg/m	
2x40x20x8	6000	1.38	◎
2x50x25x10	"	1.78	◎
2x52x20x8	"	1.58	◎
2x60x20x8	"	1.70	◎
2x70x20x8	"	1.87	◎
2x60x30x10	"	2.08	◎
2x80x40x14.5	"	2.87	◎
2x75x45x15	"	2.97	◎
2x100x50x19.5	"	3.67	◎
2x120x60x19.5	"	4.30	◎
3x40x20x8	"	1.92	◎ ■
3x60x30x10	"	2.97	◎ ■
3x75x45x15	"	4.27	◎ ■
3x100x50x20	"	5.35	◎ ■
4x60x30x10	"	3.82	◎ ■
4x80x40x15	"	5.42	◎ ■
4x100x50x20	"	7.00	◎ ■

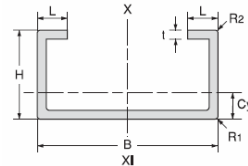

厚延H形鋼 SUS304

サイズ	長さ	kg/m	
100x100x6x8	6000	17.2	◎
125x125x6.5x9	"	23.8	◎
148x100x6x9	"	20.8	◎
150x150x7x10	"	31.3	◎
200x100x5.5x8	"	21.2	◎
200x200x8x12	"	50.3	◎
250x250x9x14	"	72.5	◎

溶接H形鋼 SUS304

サイズ	長さ	kg/m	
75x75x5x8	6000	11.9	◎
100x100x6x8	"	16.7	◎
125x125x7x9	"	23.8	◎
148x100x6x9	"	20.5	◎
150x150x8x10	"	32.0	◎
200x100x6x8	"	21.3	◎
200x200x8x12	"	49.2	◎
250x125x6x9	"	57.6	◎
250x250x9x14	"	71.3	◎
300x300x10x16	"	97.3	◎

溶接T形鋼 SUS304 ◎ = 酸洗 (HOT) ■ = 受注製作品

サイズ	長さ	kg/m	
50x50x5x5	4000	3.75	◎ ■
60x60x6x6	"	5.43	◎ ■
75x75x6x6	"	6.85	◎ ■
100x100x6x8	6000	10.7	◎ ■
125x125x6x9	"	14.4	◎ ■
50x75x6x6	"	5.67	◎ ■
50x100x6x8	"	8.33	◎ ■
75x100x8x10	"	12.1	◎ ■
75x150x8x10	"	16.0	◎ ■
100x200x8x12	"	24.7	◎ ■

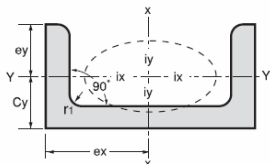
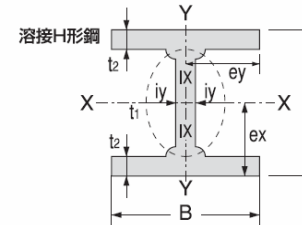
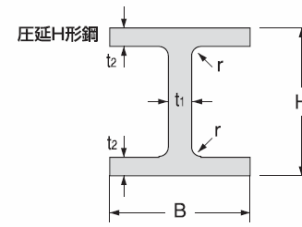

チャンネル

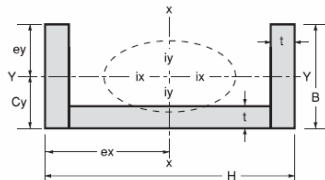

ワイドチャンネル

